



GAS LOG VENTED DECORATIVE APPLIANCE OWNER'S OPERATION AND INSTALLATION MANUAL



**VTD-18N-PDG, VTD-18P-PDG
VTD-24N-PDG, VTD-24P-PDG**



**VTD-18N-BTB, VTD-18P-BTB
VTD-24N-BTB, VTD-24P-BTB**



WARNING: If the information in this manual is not followed exactly, a fire or explosion may result causing property damage, personal injury or loss of life.

- Do not store or use gasoline or other flammable vapors and liquids in the vicinity of this or any other appliance.
- **WHAT TO DO IF YOU SMELL GAS**
 - Do not try to light any appliance.
 - Do not touch any electrical switch; do not use any phone in your building.
 - Immediately call your gas supplier from a neighbor's phone. Follow the gas supplier's instructions.
 - If you cannot reach your gas supplier, call the fire department.
- Installation and service must be performed by a qualified installer, service agency or the gas supplier.

INSTALLER: Leave this manual with the appliance
CONSUMER: Retain this manual for future reference.

TABLE OF CONTENTS

Safety Information	2	Specifications	14
Local Codes.....	4	Wiring Diagram.....	14
Product Identification.....	5	Troubleshooting.....	15
Unpacking.....	5	Service Hints	19
Product Features.....	5	Technical Service.....	19
Optional Remote Control Accessories.....	5	Replacement Parts.....	19
Installation	6	Accessories	19
Operating Heater	10	Illustrated Parts Breakdown and Parts List.....	20
Inspecting Burners	13	Warranty Information	Back Cover
Cleaning and Maintenance.....	14		

SAFETY INFORMATION

WARNING: Improper installation, adjustment, alteration, service or maintenance can cause injury or property damage. Refer to this manual for correct installation and operational procedures. For assistance or additional information consult a qualified installer, service agency or the gas supplier.

This appliance may be installed in an aftermarket,* permanently located, manufactured (mobile) home, where not prohibited by local codes.

This appliance is only for use with the type of gas indicated on the rating plate. This appliance is not convertible for use with other gases.

* Aftermarket: Completion of sale, not for purpose of resale, from the manufacturer

WARNING: This appliance is for installation only in a solid-fuel burning masonry or UL127 factory-built fireplace, constructed of noncombustible material and connected to a working flue. (See page 6 for minimum flue opening.)

WARNING: This is a gas-fired heater. It uses air (oxygen) from the room in which it is installed. Provisions for adequate combustion and ventilation air must be provided. Refer to the *National Fuel Gas Codes, ANSI Z233.1/NFPA 54, Section 5.3, Air for Combustion and Ventilation.*

State of Massachusetts: The installation must be made by a licensed plumber or gas fitter in the Commonwealth of Massachusetts.

SAFETY INFORMATION

Continued

⚠ WARNING: This product contains and/or generates chemicals known to the State of California to cause cancer or birth defects or other reproductive harm.

⚠ WARNING: Keep flue open when operating unit.

IMPORTANT: Read this owner's manual carefully and completely before trying to assemble, operate or service this heater. Improper use of this heater can cause serious injury or death from burns, fire, explosion, electrical shock and carbon monoxide poisoning.

⚠ DANGER: Carbon monoxide poisoning may lead to death!

Carbon Monoxide Poisoning: Early signs of carbon monoxide poisoning resemble the flu, with headaches, dizziness or nausea. If you have these signs, the heater may not be working properly. **Get fresh air at once!** Have heater serviced. Some people are more affected by carbon monoxide than others. These include pregnant women, people with heart or lung disease or anemia, those under the influence of alcohol and those at high altitudes.

Natural and Propane/LP Gas: Natural and propane/LP gases are odorless. An odor-making agent is added to these gases. The odor helps you detect a gas leak. However, the odor added to the gas can fade. Gas may be present even though no odor exists.

Make certain you read and understand all warnings. Keep this manual for reference. It is your guide to safe and proper operation of this heater.

⚠ WARNING: Any change to this heater or its controls can be dangerous.

⚠ WARNING: Do not use a blower insert, heat exchanger insert or other accessory not approved for use with this heater.

⚠ WARNING: Do not allow fans to blow directly into the heater. Avoid any drafts that alter burner flame patterns. Ceiling fans can create drafts that alter burner flame patterns. Altered burner patterns can cause sooting.

⚠ WARNING: Do not place log scraps or lava rocks on burner.

Due to high temperatures, the appliance should be located out of traffic and away from furniture and draperies.

Do not place clothing or other flammable material on or near the appliance. Never place any objects on the heater.

Heater base assembly becomes very hot when running heater. Keep children and adults away from hot surface to avoid burns or clothing ignition. Heater will remain hot for a time after shutdown. Allow surface to cool before touching.

Carefully supervise young children when they are in the room with heater. When using the handheld remote accessory, keep selector switch in the OFF position to prevent children from turning on burners with remote.

SAFETY INFORMATION

Continued

You must operate this heater with a fireplace doors or screen in place and fully closed. Unless provided by other means, screens shall have openings for introduction of combustion air.

Keep the appliance area clear and free from combustible materials, gasoline and other flammable vapors and liquids.

1. This appliance is only for use with the type of gas indicated on the rating plate. This appliance is not convertible for use with other gases.
2. Do not place propane/LP supply tank(s) inside any structure. Locate propane/LP supply tank(s) outdoors (propane/LP units only).
3. If you smell gas
 - shut off gas supply
 - do not try to light any appliance
 - do not touch any electrical switch; do not use any phone in your building
 - immediately call your gas supplier from a neighbor's phone. Follow the gas supplier's instructions
 - if you cannot reach your gas supplier, call the fire department
4. Never install log set
 - in a recreational vehicle
 - where curtains, furniture, clothing or other flammable objects are less than 42" from the front, tip or sides of the log set
 - in high traffic areas
 - in windy or drafty areas
5. Before installing in a solid fuel burning fireplace, the chimney flue and firebox must be cleaned of soot, creosote, ashes and loose paint by a qualified chimney cleaner. Creosote will ignite if highly heated. Inspect chimney flue for damage. If damaged, repair flue before operating heater.
6. Do not burn solid-fuel in the fireplace after installing the log set. Do not use this log set to cook food or burn paper or other objects.
7. This log set is designed to be smokeless. If logs ever appear to smoke, turn off appliance and call a qualified service person. **Note:** During initial operation, slight smoking could occur due to log curing and burning of manufacturing residues. You may wish to add more ventilation by opening a window.
8. To reduce the creation of soot, follow the instructions in *Cleaning and Maintenance*, page 14.
9. Before using furniture polish, wax, carpet cleaner or similar products, turn heater off. If heated, the vapors from these products may create a white powder residue within burner box or on adjacent walls or furniture.
10. Do not run heater
 - where flammable liquids or vapors are used or stored
 - under dusty conditions
11. Do not use heater if any part has been exposed to or under water. Immediately call a qualified service technician to inspect the room heater and to replace any part of the control system and any gas control which has been under water.
12. Do not operate heater if any log is broken. Do not operate heater if a log is chipped (dime-sized or larger).
13. Turn heater off and let cool before servicing or repairing. Make sure the selector switch is in the OFF position. Only a qualified service person should install, service or repair heater.
14. To prevent performance problems, do not use propane/LP fuel tank of less than 100 lb. capacity (propane/LP units only).
15. The installation and provisions for combustion and ventilation air must conform with the *National Fuel Gas Codes, ANSI Z223.1/NFPA 54, Section 5.3, Air for Combustion and Ventilation*.
16. Provide adequate clearances around air openings.

LOCAL CODES

Install and use heater with care. Follow all local codes. In the absence of local codes, use the latest edition of *The National Fuel Gas Code ANSI Z223.1/NFPA 54**.

*Available from:

American National Standards Institute, Inc.
1430 Broadway
New York, NY 10018

National Fire Protection Association, Inc.
Batterymarch Park
Quincy, MA 02269

Note: Where listed vented decorative logs are required, thermostat operation

PRODUCT IDENTIFICATION

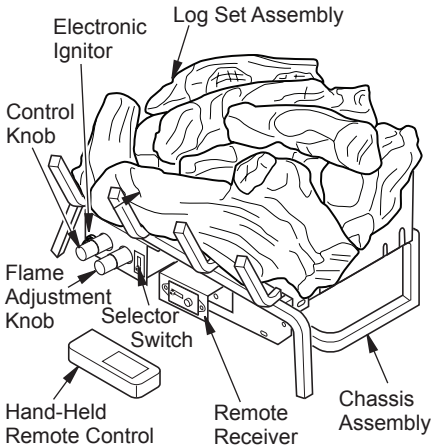

BTB Models

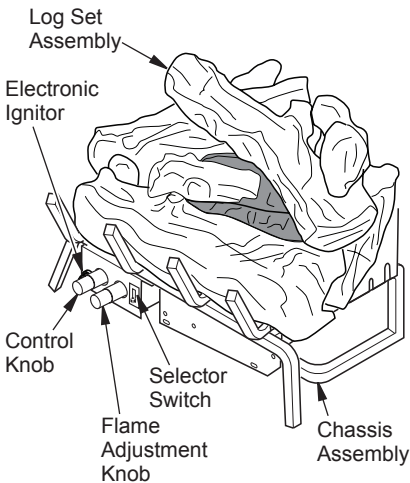

PDG Models

Figure 1 - Product Identification

UNPACKING

CAUTION: Do not remove the data plates from the grate assembly. The data plates contain important warranty and safety information.

1. Remove log set assembly from carton.
Note: Do not pick up assembly by logs. This could damage heater. Always handle assembly by grate.
2. Remove control cover floor media components.
3. Remove all protective packaging applied to log set for shipment.
3. Check all items for any shipping damage. If damaged, promptly inform dealer where you bought heater.

PRODUCT FEATURES

OPERATION

This unitized gas log set is tested and approved to ANSI Z21.60a and CSA 2.26a-2000 as a vented decorative appliance.

SAFETY DEVICE

This heater has a pilot with an Oxygen Depletion Sensing (ODS) safety shutoff system. The ODS/pilot shuts off the heater if there is not enough fresh air.

ELECTRONIC IGNITION SYSTEM

This system has an electronic ignitor. This system requires no matches or other sources to light heater. Receiver requires 4 AA batteries (included), hand-held remote control requires a 12-volt battery and a 3-volt button cell battery for the LCD display (both included).

OPTIONAL REMOTE CONTROL ACCESSORIES

There are two optional remote accessories available for the PDG log set models that come standard with the BTB log set models:

- wall switch
- hand-held ON/OFF remote

See *Accessories*, page 19.

INSTALLATION

⚠ WARNING: Make sure the selector switch is in the OFF position before installing heater.

⚠ WARNING: Before installing in a solid fuel burning fireplace, the chimney flue and firebox must be cleaned of soot, creosote, ashes and loose paint by a qualified chimney cleaner. Creosote will ignite if highly heated. A dirty chimney flue may create and distribute soot within the house. Inspect chimney and firebox flue for damage. If damaged, repair flue and firebox before operating heater.

⚠ WARNING: Installation, service and repair of this appliance must be performed by a qualified installer, service agency, company or gas supplier experienced with this type of gas appliance. Only factory authorized components listed in these instructions may be used in accordance with manufacturer's instructions and all codes and requirements of the authority having jurisdiction. Any modifications to this kit, or use of unauthorized components or accessory items will void manufacturer's warranty and may result in a hazardous condition.

INSTALLATION AND CLEARANCES

Figure 2 shows technical information regarding installation of your gas log set. Please make sure all specifications shown are applicable before installation is attempted.

SPECIFICATIONS (W.C.)			
FUEL INLET PRESSURE		MANIFOLD PRESSURE	
	Min.	Max.	
NG	7"	10.5"	3.5"
LP	11"	14"	10"

Figure 2 - Technical Information Chart

Flue Opening Specifications

Note: This vented appliance must be installed only in a solid-fuel burning or UL127 factory-built fireplace with a working flue and constructed of noncombustible material. The fireplace must include a working flue and venting system with minimum openings shown in Figure 3.

LOG SIZING REQUIREMENTS					Min. Flue Size
Minimum Firebox Size					
Log Size	Height	Depth	Front Width	Rear* Width	
18"	17"	14"	24"	20"	8"
24"	17"	14"	28"	22"	8"

*Measured at 14" depth.

Figure 3 - Sizes and Clearances

CHECK GAS TYPE

Use the correct gas type (natural or propane/LP) for your unit. If your gas supply is not correct, do not install heater. Call dealer where you bought heater for proper type heater.

⚠ WARNING: This appliance is equipped for (natural or propane/LP) gas. Field conversion is not permitted.

VENTING SPECIFICATIONS FOR INSTALLATION

The fireplace chimney flue and vent must be drafted properly. To check vent for proper drafting: Light a tightly rolled newspaper on one end and place it at the inside front edge of fireplace. Observe smoke and be sure vent is properly drawing it up the chimney. If smoke spills out into the room, extinguish flame and remove any obstruction until proper venting is achieved.

The chimney flue damper must be fixed open to provide a minimum of 43 square inches of free air opening during operation of this log set. A multipurpose damper clamp is provided to fix the damper in position.

INSTALLATION

Continued

The minimum flue sizes shown in Figure 3, page 6, are based on a 6' chimney height using round pipe. Your minimum flue size will vary based on input rate and chimney height. Refer to the *National Fuel Gas Code ANSI Z223.1/NFPA 54, Section 6.6* for details.

INSTALLING DAMPER CLAMP

Secure damper stop clamp to edge of damper as shown in Figure 4. If for any reason this clamp doesn't work on your fireplace, another suitable clamp or permanent stop must be installed or damper blade must be removed.

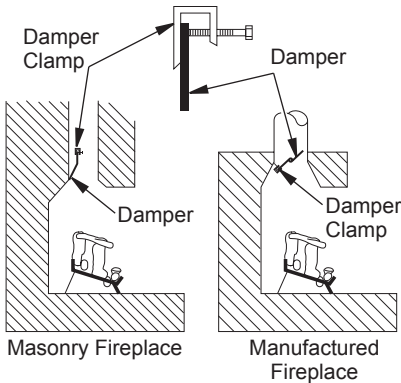

Figure 4 - Attaching Damper Clamp

INSTALLING HEATER ASSEMBLY

CAUTION: Do not remove the data plates attached to the heater base assembly. The data plates contain important warranty and safety information.

WARNING: If installing in a sunken fireplace, special care is needed. You must raise the fireplace floor to allow access to heater control panel. This will insure adequate air flow and guard against sooting and controls being damaged. Raise fireplace floor with noncombustible material. Make sure material is secure.

CAUTION: Do not pick up heater assembly by the logs. This could damage heater. Only handle base assembly by grates.

IMPORTANT: Make sure appliance is level. If heater is not level, heater will not work properly.

Installation Items Needed

- control cover kit (provided with heater)
- approved flexible gas hose (provided) (if allowed by local codes)
- sealant (resistant to propane/LP gas, not provided)
- pipe wrench

Note: Install optional remote control accessories (see *Accessories*, page 19) before installing gas log heater.

1. Apply pipe joint sealant lightly to male threads of gas fitting (not provided). Connect approved flexible gas hose to inlet side of gas control (see Figure 5). **IMPORTANT:** Hold gas fitting with wrench when connecting flexible gas hose.
2. Position heater assembly in fireplace.
3. Connect to gas supply. See *Connecting to Gas Supply*.

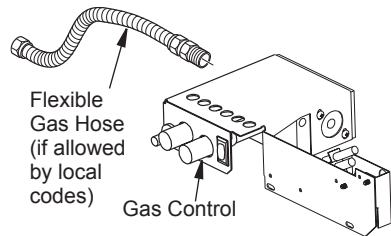

Figure 5 - Attaching Flexible Gas Hose to Heater Gas Regulator

CONNECTING TO GAS SUPPLY

WARNING: This appliance requires a 3/8" NPT (National Pipe Thread) inlet connection to the pressure regulator.

WARNING: A qualified service person must connect heater to gas supply. Follow all local codes.

INSTALLATION

Continued

CAUTION: Never connect propane/LP fireplace directly to the propane/LP supply. This heater requires an external regulator (not supplied). Install the external regulator between the heater and propane/LP supply.

WARNING: Never connect natural gas fireplace to private (non-utility) gas wells. This gas is commonly known as wellhead gas.

Installation Items Needed

Before installing heater, make sure you have the items listed below.

- external regulator (for propane/LP units only, supplied by installer)
- piping (check local codes)
- sealant (resistant to propane/LP gas)
- equipment shutoff valve *
- test gauge connection *
- sediment trap
- tee joint
- pipe wrench
- approved flexible gas line with gas connector (if allowed by local codes) (provided)

* A CSA design-certified equipment shutoff valve with 1/8" NPT tap is an acceptable alternative to test gauge connection. Purchase the optional CSA design-certified equipment shutoff valve from your dealer. See *Accessories*, page 19.

For propane/LP units, the installer must supply an external regulator. The external regulator will reduce incoming gas pressure. You must reduce incoming gas pressure to between 11" and 14" of water. If you do not reduce incoming gas pressure, heater regulator damage could occur. Install external regulator with the vent pointing down as shown in Figure 6. Pointing the vent down protects it from freezing rain or sleet.

CAUTION: Use only new, black iron or steel pipe. Internally-tinned copper tubing may be used in certain areas. Check your local codes. Use pipe of 1/2" diameter or greater to allow proper gas volume to heater. If pipe is too small, undue loss of volume will occur.

Installation must include an equipment shutoff valve, union and plugged 1/8" NPT tap. Locate NPT tap within reach for test gauge hook up. NPT tap must be upstream from heater (see Figure 7).

IMPORTANT: Install equipment shutoff valve in an accessible location. The equipment shutoff valve is for turning on or shutting off the gas to the appliance.

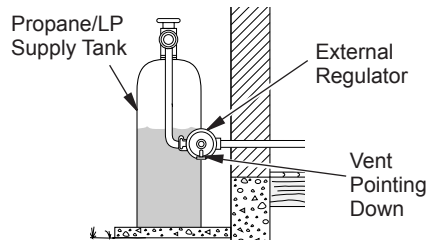

Figure 6 - External Regulator With Vent Pointing Down

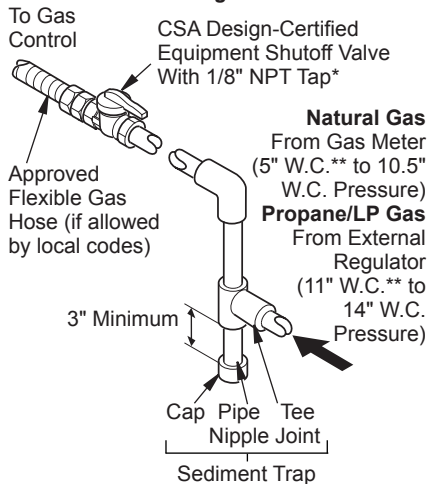

Figure 7 - Gas Connection

* Purchase the optional CSA design-certified equipment shutoff valve from your dealer. See *Accessories*, page 25.

** Minimum inlet pressure for purpose of input adjustment.

INSTALLATION

Continued

Check your building codes for any special requirements for locating equipment shutoff valve to fireplaces.

Apply pipe joint sealant lightly to male NPT threads. This will prevent excess sealant from going into pipe. Excess sealant in pipe could result in clogged heater valves.

⚠ WARNING: Use pipe joint sealant that is resistant to liquid petroleum (LP) gas.

We recommend that you install a sediment trap in supply line as shown in Figure 7, page 8. Locate sediment trap where it is within reach for cleaning. Install in piping system between fuel supply and heater. Locate sediment trap where trapped matter is not likely to freeze. A sediment trap traps moisture and contaminants. This keeps them from going into heater controls. If sediment trap is not installed or is installed wrong, heater may not run properly.

⚠ CAUTION: Avoid damage to gas control. Hold gas control with wrench when connecting it to gas piping and/or fittings.

CHECKING GAS CONNECTIONS

⚠ WARNING: Test all gas piping and connections, internal and external to unit, for leaks after installing or servicing. Correct all leaks at once.

⚠ WARNING: Never use an open flame to check for a leak. Apply a noncorrosive leak detection fluid to all joints. Bubbles forming show a leak. Correct all leaks at once.

⚠ CAUTION: Make sure external regulator has been installed between propane/LP supply and heater. See guidelines under *Connecting to Gas Supply*, page 7.

PRESSURE TESTING GAS SUPPLY PIPING SYSTEM

Test Pressures In Excess Of 1/2 PSIG (3.5 kPa)

1. Disconnect appliance with its appliance main gas valve (control valve) and equipment shutoff valve from gas supply piping system. Pressures in excess of 1/2 psig will damage heater regulator.
2. Cap off open end of gas pipe where equipment shutoff valve was connected.
3. Pressurize supply piping system by either opening propane/LP supply tank valve for propane/LP gas or opening main gas valve located on or near gas meter for natural gas or using compressed air.
4. Check all joints of gas supply piping system. Apply noncorrosive leak detection fluid to all joints. Bubbles forming show a leak.
5. Correct all leaks at once.
6. Reconnect heater and equipment shutoff valve to gas supply. Check reconnected fittings for leaks.

Test Pressures Equal To or Less Than 1/2 PSIG (3.5 kPa)

1. Close equipment shutoff valve (see Figure 8).
2. Pressurize supply piping system by either opening propane/LP supply tank valve for propane/LP gas or opening main gas valve located on or near gas meter for natural gas or using compressed air.

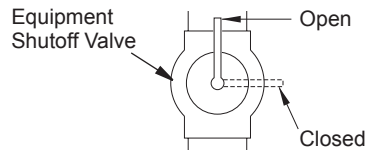

Figure 8 - Equipment Shutoff Valve

INSTALLATION

Continued

3. Check all joints from gas meter to equipment shutoff valve for natural gas or propane/LP supply to equipment shutoff valve for propane/LP (see Figure 9 or 10). Apply noncorrosive leak detection fluid to all joints. Bubbles forming show a leak.
4. Correct all leaks at once.

PRESSURE TESTING HEATER GAS CONNECTIONS

1. Open equipment shutoff valve (see Figure 8, page 9).
2. Open main gas valve located on or near gas meter for natural gas or open propane/LP supply tank valve.
3. Make sure control knob of heater is in the OFF position.
4. Check all joints from equipment shutoff valve to control valve (see Figure 9 or 10). Apply noncorrosive leak detection fluid to all joints. Bubbles forming show a leak.
5. Correct all leaks at once.
6. Light heater (see *Operating Heater*). Check all other internal joints for leaks.
7. Turn off heater (see *To Turn Off Gas to Appliance*, page 10).

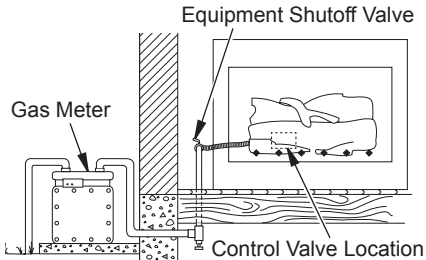

Figure 9 - Checking Gas Joints for Natural Gas

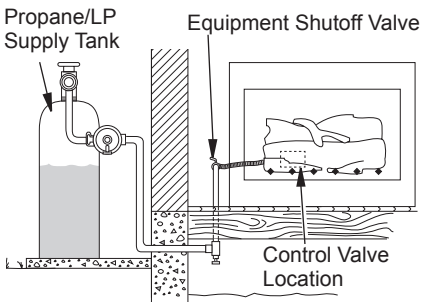

Figure 10 - Checking Gas Joints for Propane/LP Gas

OPERATING HEATER

FOR YOUR SAFETY READ BEFORE LIGHTING

WARNING: Keep flue open when operating unit.

WARNING: If you do not follow these instructions exactly, a fire or explosion may result causing property damage, personal injury or loss of life.

- A. This appliance has a pilot which must be lighted by hand. When lighting the pilot, follow these instructions exactly.
- B. **BEFORE LIGHTING** smell all around the appliance area for gas. Be sure to smell next to the floor because some gas is heavier than air and will settle on the floor.
WHAT TO DO IF YOU SMELL GAS
 - Do not try to light any appliance.
 - Do not touch any electric switch; do not use any phone in your building.
 - Immediately call your gas supplier from a neighbor's phone. Follow the gas supplier's instructions.
 - If you cannot reach your gas supplier, call the fire department.
- C. Use only your hand to push in or turn the gas control knob. Never use tools. If the knob will not push in or turn by hand, don't try to repair it, call a qualified service technician or gas supplier. Force or attempted repair may result in a fire or explosion.
- D. Do not use this appliance if any part has been under water. Immediately call a qualified service technician to inspect the appliance and to replace any part of the control system and any gas control which has been under water.

OPERATING HEATER

Continued

LIGHTING INSTRUCTIONS

NOTICE: During initial operation of new heater, burning logs will give off a paper-burning smell. Orange flame will also be present. Open damper or window to vent smell. This will only last a few hours.



⚠ WARNING: Damper handle will be hot if appliance has been running.

⚠ CAUTION: A mild gas flash within 10 seconds is normal during shutdown of this heater. Remain clear of the hearth area for the entire shutdown process to avoid possible injury.

NOTICE: During initial operation of new heater, metallic components may emit an odor as paint and assembly compounds are heated and cure. Be sure to provide adequate fresh air if odors are detected.

1. STOP! Read the safety information on page 10.
2. Make sure equipment shutoff valve is fully open.
3. Set selector switch in the OFF position.
4. Turn motor knob clockwise  to the OFF position.

⚠ WARNING: Burners will come on automatically within one minute when the selector switch is in the ON position after the pilot is lit.

5. Wait five (5) minutes to clear out any gas. Then smell for gas, including near the floor. If you smell gas, STOP! Follow “B” in the safety information, page 10. If you don’t smell gas, go to the next step.
6. Press in and turn control knob counterclockwise  to the PILOT position. Press in control knob for five (5) seconds (see Figure 11).
Note: You may be running this heater for the first time after hooking up to gas supply. If so, the control knob may need to be pressed in for 30 seconds or more. This will allow air to bleed from the gas system.
7. With control knob pressed in, press ignitor button. This will light pilot. The pilot is attached to the front burner. If needed, keep pressing ignitor button until pilot lights.
Note: If pilot does not stay lit, contact a qualified service person or gas supplier for repairs. Until repairs are made, light pilot with match. To light pilot with match, see *Manual Lighting Procedure*.
8. Keep control knob pressed in for 30 seconds after lighting pilot. After 30 seconds, release control knob.
 - If control knob does not pop out when released, contact a qualified service person or gas supplier for repairs.**Note:** If pilot goes out, repeat steps 4 through 8.
9. Slightly push in and turn control knob counterclockwise  to the ON position.
10. Wait one minute and switch selector switch to the ON position to light burners.
11. Set flame adjustment knob to any level between HI and LO.

⚠ CAUTION: Do not try to adjust heating levels by using the equipment shutoff valve.

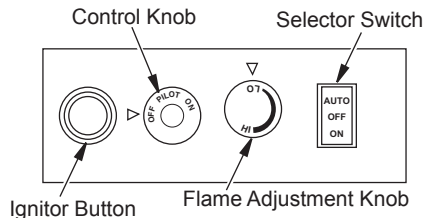

Figure 11 - Control Knob and Ignitor Button Locations

OPERATING HEATER

Continued

⚠ WARNING: Make sure selector switch is in to OFF position when you are away from home for long periods of time. Appliance will come on automatically with selector switch in the ON position.

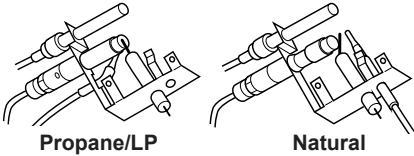



Figure 12 - Pilot (Remote Shown)

TO TURN OFF GAS TO APPLIANCE

Shutting Off Heater

1. Turn control knob clockwise  to the OFF position.
- 2a. Set selector switch in the OFF position.
- 2b. If Using Optional Hand-Held Remote: Set selector switch in the OFF position to prevent draining battery.

Shutting Off Burner Only (pilot stays lit)

You may shut off the burners and keep the pilot lit by doing one of the following:

1. Turn control knob clockwise  to the PILOT position.
2. Use remote control manual OFF button.
3. Set selector switch in the OFF position.

MANUAL LIGHTING PROCEDURE

1. Follow steps 1 through 6 under *Lighting Instructions*, page 16.
2. Depress control knob and light pilot with match.
3. Keep control knob pressed in for 30 seconds after lighting pilot. After 30 seconds, release control knob. Now follow steps 9 through 11, *Lighting Instructions*, page 17.

OPTIONAL HAND-HELD REMOTE CONTROL OPERATION

1. After lighting, let pilot flame burn for about one minute. Turn control knob to ON position. Adjust flame adjustment knob anywhere between HI and LO. Set toggle selector switch to AUTO. Slide remote selector switch to REMOTE position (see Figure 13). **Note:** The burner may light if hand-held remote was on when selector switch was last turned off. You can now turn the burner on and off with the hand-held remote control unit.

IMPORTANT: Do not leave the selector switch in the REMOTE or ON position when the pilot is not lit. This will drain the battery.

2. Press ON/OFF button to turn burners on and off. When turning burners off, the pilot will remain lit.

IMPORTANT: Be sure to press ON/OFF buttons on hand-held remote control unit for up to 3 seconds to assure proper operation.

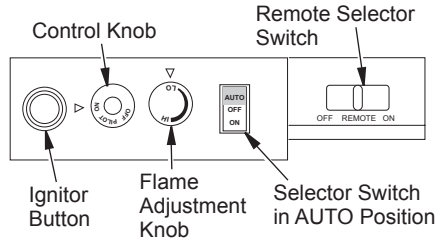

Figure 13 - Control Knob and Ignitor Button Locations for Remote Control

Remote Control Specifications

Batteries: (See instructions with remote for removing and installing batteries)

Transmitter requires 12V (A-23) and 3V button cell for LCD (both included)

Remote receiver requires 4 AA (1.5V) alkaline batteries (included)

Operating Frequency: 303.875 MHz

INSPECTING BURNERS

Check pilot flame pattern and burner flame patterns often.

PILOT FLAME PATTERN

Figure 14 shows a correct pilot flame pattern. Figure 15 shows an incorrect pilot flame pattern. The incorrect pilot flame is not touching the thermocouple. When the thermocouple cools, the heater will shut down.

If pilot flame pattern is incorrect, as shown in Figure 15

- turn heater off (see *To Turn Off Gas to Appliance*, page 12)
- see *Troubleshooting*, page 15

Note: The pilot flame on natural gas units will have a slight curve, but flame should be blue and have no yellow or orange color.

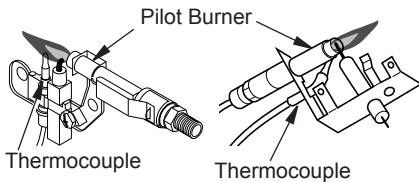

Figure 14 - Correct Pilot Flame Pattern
(Your Pilot May Differ from Pilots Shown)

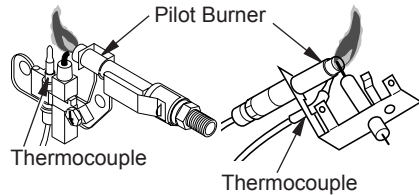

Figure 15 - Incorrect Pilot Flame Pattern
(Your Pilot May Differ from Pilots Shown)

BURNER FLAME PATTERN

Figure 16 shows correct burner flame pattern.

NOTICE: Do not mistake orange flames with yellow tipping. Dirt or other fine particles are burned by heater, causing brief patches of orange flame.

If burner flame pattern is incorrect, as shown in Figure 17

- turn appliance off (see *To Turn Off Gas to Appliance*, page 12)
- see *Troubleshooting*, page 15

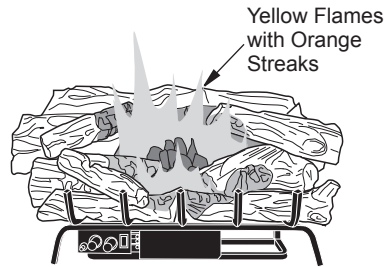

Figure 16 - Correct Burner Flame Pattern

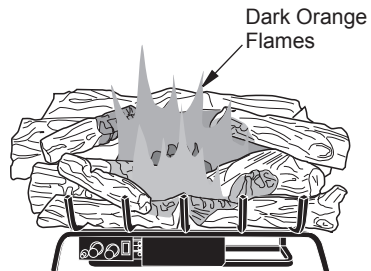

Figure 17 - Incorrect Burner Flame Pattern

CLEANING AND MAINTENANCE

⚠ WARNING: Turn off heater and let cool before cleaning.

⚠ CAUTION: You must keep control areas, burner and circulating air passageways of fireplace clean. Inspect these areas of fireplace before each use. Have fireplace and chimney inspected yearly by a qualified service person. Fireplace may need more frequent cleaning due to excessive lint from carpeting, bedding material, pet hair, etc.

Only limited cleaning will be required under normal use of this appliance. Dust front grate and top of receiver/valve. Do not use cleaning fluids to clean logs or any other part of the appliance.

If after a period of use the flames start to exhibit unusual shapes and behavior or burner fails to ignite smoothly, burner holes may require cleaning. If this happens, we recommend you contact your nearest authorized service technician to get the appliance serviced.

- Keep area around log set clean and clear of debris.
- Periodically inspect burner for foreign matter blocking air inlet and flame holes.
- Once every year a qualified agency or certified chimney sweep should examine and clean venting system of fireplace.

SPECIFICATIONS

Models VTD-18N-PDG and VTD-18N-BTB

- Input Rating: 37,000/54,000 Btu/Hr
- Fuel: Natural Gas
- Ignition: Electronic
- Manifold Pressure: 3.5" W.C.
- Inlet Gas Pressure (in. of water): Max. - 10.5", Min. - 5.0*
- Shipping Weight: 32 lbs.

Models VTD-18P-PDG and VTD-18P-BTB

- Input Rating: 30,000/46,000 Btu/Hr
- Fuel: Propane/LP Gas
- Ignition: Electronic
- Manifold Pressure: 10" W.C.
- Inlet Gas Pressure (in. of water): Max. - 14", Min. - 11"*
- Shipping Weight: 32 lbs.

Models VTD-24N-PDG and VTD-24N-BTB

- Input Rating: 41,000/58,000 Btu/Hr
- Fuel: Natural Gas
- Ignition: Electronic
- Manifold Pressure: 3.5" W.C.
- Inlet Gas Pressure (in. of water): Max. - 10.5", Min. - 5.0*
- Shipping Weight: 34 lbs.

Models VTD-24P-PDG and VTD-24P-BTB

- Input Rating: 41,000/58,000 Btu/Hr
- Fuel: Propane/LP Gas
- Ignition: Electronic
- Manifold Pressure: 10" W.C.
- Inlet Gas Pressure (in. of water): Max. - 14", Min. - 11"*
- Shipping Weight: 34 lbs.

* For purpose of input adjustment

WIRING DIAGRAM

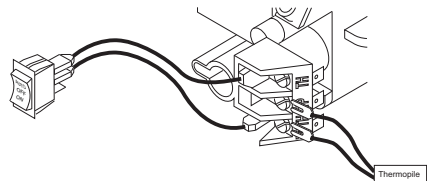

TROUBLESHOOTING

 **WARNING:** Turn off heater and let cool before servicing. Only a qualified service person should service and repair heater.

 **CAUTION:** Never use a wire, needle or similar object to clean ODS/pilot. This can damage ODS/pilot unit.

Note: All troubleshooting items are listed in order of operation.

OBSERVED PROBLEM	POSSIBLE CAUSE	REMEDY
When ignitor button is pressed, there is no spark at ODS/pilot	1. Ignitor electrode not connected to ignitor cable	1. Reconnect ignitor cable
	2. Ignitor cable pinched or wet	2. Free ignitor cable if pinched by any metal or tubing. Keep ignitor cable dry
	3. Electronic ignitor battery is weak	3. Replace battery
	4. Broken ignitor cable	4. Replace ignitor cable
	5. Bad electronic ignitor	5. Replace electronic ignitor
	6. Ignitor electrode positioned wrong or broken	6. Replace pilot assembly
When ignitor button is pressed, there is spark at ODS/pilot but no ignition	1. Gas supply turned off or equipment shutoff valve closed	1. Turn on gas supply or open equipment shutoff valve
	2. Control knob not in PILOT position	2. Turn control knob to PILOT position
	3. Control knob not pressed in while in PILOT position	3. Press in control knob while in PILOT position
	4. Air in gas lines when installed	4. Continue holding down control knob. Repeat igniting operation until air is removed
	5. Depleted gas supply (propane/LP only)	5. Contact local propane/LP gas company
	6. ODS/pilot is clogged	6. Clean ODS/pilot (see <i>Cleaning and Maintenance</i> , page 14) or replace ODS/pilot assembly
	7. Gas regulator setting is not correct	7. Replace gas regulator

TROUBLESHOOTING

Continued

OBSERVED PROBLEM	POSSIBLE CAUSE	REMEDY
ODS/pilot lights but flame goes out when control knob is released	1. Control knob not fully pressed in	1. Press in control knob fully
	2. Control knob not pressed in long enough	2. After ODS/pilot lights, keep control knob pressed in 30 seconds
	3. Safety interlock system has been triggered	3. Wait one minute for safety interlock system to reset. Repeat ignition operation
	4. Equipment shutoff valve not fully open	4. Fully open equipment shutoff valve
	5. Pilot flame not touching thermocouple, which allows thermocouple to cool, causing pilot flame to go out. This problem could be caused by one or both of the following: A) Low gas pressure B) Dirty or partially clogged ODS/pilot	5. A) Contact local natural or propane/LP gas company B) Clean ODS/pilot (see <i>Cleaning and Maintenance</i> , page 14) or replace ODS/pilot assembly
	6. Thermocouple connection loose at control valve	6. Hand tighten until snug, then tighten 1/4 turn more
	7. Thermocouple damaged	7. Replace pilot assembly
	8. Control valve damaged	8. Replace control valve
Burner does not light after ODS/pilot is lit	1. Inlet gas pressure is too low	1. Contact local natural or propane/LP gas company
	2. Burner orifice clogged	2. Clean burner (see <i>Cleaning and Maintenance</i> , page 14) or replace burner orifice
	3. Remote selector in OFF position	3. Put remote selector in ON position
	4. Wire disconnected from gas control	4. See <i>Wiring Diagram</i> , page 14
Delayed ignition of burner	1. Manifold pressure is too low	1. Contact local natural or propane/LP gas company
	2. Burner orifice clogged	2. Clean burner (see <i>Cleaning and Maintenance</i> , page 14) or replace burner orifice
Burner backfiring during combustion	1. Burner orifice is clogged or damaged	1. Clean burner (see <i>Cleaning and Maintenance</i> , page 14) or replace burner orifice
	2. Damaged burner	2. Replace damaged burner
	3. Gas regulator defective	3. Replace gas regulator

TROUBLESHOOTING

Continued

OBSERVED PROBLEM	POSSIBLE CAUSE	REMEDY
Orange flame in burner during burner combustion	<ol style="list-style-type: none">1. Not enough air2. Gas regulator defective	<ol style="list-style-type: none">1. Check burner for dirt and debris. If found, clean burner (see <i>Cleaning and Maintenance</i>, page 14)2. Replace gas regulator
Slight smoke or odor during initial operation	<ol style="list-style-type: none">1. Residues from manufacturing processes and logs curing	<ol style="list-style-type: none">1. Problem will stop after a few hours of operation
Heater produces a whistling noise when burner is lit	<ol style="list-style-type: none">1. Turning control knob to HI position when burner is cold2. Air in gas line3. Air passageways on heater blocked4. Dirty or partially clogged burner orifice	<ol style="list-style-type: none">1. Turn control knob to LO position and let warm up for a minute2. Operate burner until air is removed from line. Have gas line checked by local natural or propane/LP gas company3. Observe minimum installation clearances (see pages 6)4. Clean burner (see <i>Cleaning and Maintenance</i>, page 14) or replace burner orifice
White powder residue forming within burner box or on adjacent walls or furniture	<ol style="list-style-type: none">1. When heated, vapors from furniture polish, wax, carpet cleaners, etc. turn into white powder residue	<ol style="list-style-type: none">1. Turn heater off when using furniture polish, wax, carpet cleaners, or similar products
Remote does not function	<ol style="list-style-type: none">1. Battery is not installed. Battery power is low	<ol style="list-style-type: none">1. Replace batteries in receiver and remote control
Heater produces a clicking/ticking noise just after burners are lit or shut off	<ol style="list-style-type: none">1. Metal expanding while heating or contracting while cooling	<ol style="list-style-type: none">1. This is common with most heaters. If noise is excessive, contact qualified service person

TROUBLESHOOTING

Continued



WARNING: If you smell gas

- Shut off gas supply.
- Do not try to light any appliance.
- Do not touch any electrical switch; do not use any phone in your building.
- Immediately call your gas supplier from a neighbor's phone. Follow the gas supplier's instructions.
- If you cannot reach your gas supplier, call the fire department.

IMPORTANT: Operating heater where impurities in air exist may create odors. Cleaning supplies, paint, paint remover, cigarette smoke, cements and glues, new carpet or textiles, etc., create fumes. These fumes may mix with combustion air and create odors. These odors will disappear over time.

OBSERVED PROBLEM	POSSIBLE CAUSE	REMEDY
Heater produces unwanted odors	<ol style="list-style-type: none">1. Heater burning vapors from paint, hair spray, glues, cleaners, chemicals, new carpet, etc. (See <i>IMPORTANT</i> statement above)2. Low fuel supply (propane/LP only)3. Gas leak. See Warning statement at top of page	<ol style="list-style-type: none">1. Open flue to maximum. Stop using odor causing products while heater is running2. Refill supply tank (propane/LP only)3. Locate and correct all leaks (see <i>Checking Gas Connections</i>, page 9)
Heater shuts off in use (ODS operates)	<ol style="list-style-type: none">1. Not enough fresh air is available2. Low line pressure3. ODS/pilot is partially clogged	<ol style="list-style-type: none">1. Open window and/or door for ventilation2. Contact local natural or propane/LP gas company3. Clean ODS/pilot (see <i>Cleaning and Maintenance</i>, page 14)
Gas odor even when control knob is in OFF position	<ol style="list-style-type: none">1. Gas leak. See Warning statement at top of page2. Control valve or gas control defective	<ol style="list-style-type: none">1. Locate and correct all leaks (see <i>Checking Gas Connections</i>, page 9)2. Replace control valve or gas control
Gas odor during combustion	<ol style="list-style-type: none">1. Foreign matter between control valve and burner2. Gas leak. See Warning statement at top of page	<ol style="list-style-type: none">1. Take apart gas tubing and remove foreign matter2. Locate and correct all leaks (see <i>Checking Gas Connections</i>, page 9)

SERVICE HINTS

When Gas Pressure Is Too Low

- pilot will not stay lit
- burners will have delayed ignition
- heater will not produce specified heat
- propane/LP gas supply may be low

You may feel your gas pressure is too low. If so, contact your local propane/LP or natural gas supplier.

TECHNICAL SERVICE

You may have further questions about installation, operation, or troubleshooting. If so, contact DESA's Technical Service Department at 1-866-672-6040. When calling please have your model and serial numbers of your appliance ready.

You can also visit DESA's technical services web site at www.desatech.com.

REPLACEMENT PARTS

Note: Use only original replacement parts. This will protect your warranty coverage for parts replaced under warranty.

PARTS UNDER WARRANTY

Contact authorized dealers of this product. If they can't supply original replacement part(s), call DESA's Technical Service Department at 1-866-672-6040.

When calling DESA, have ready

- your name
- your address
- model and serial numbers of your appliance
- how appliance was malfunctioning
- type of gas used (propane/LP or natural gas)
- purchase date

Usually, we will ask you to return the part to the factory.

PARTS NOT UNDER WARRANTY

Contact authorized dealers of this product. If they can't supply original replacement part(s), call DESA at 1-866-672-6040 for referral information.

When calling DESA, have ready

- model number of your appliance
- the replacement part number

ACCESSORIES

Purchase these heater accessories from your local dealer. If they can not supply these accessories, call DESA at 1-866-672-6040 for referral information. You can also write to the address listed on the back page of this manual.

EQUIPMENT SHUTOFF VALVE - GA5010

For all models. Equipment shutoff valve with 1/8" NPT tap. Fits 1/2" NPT pipe.

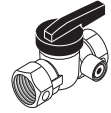

RECEIVER AND HAND-HELD REMOTE CONTROL KIT - 112806-01 (Not Shown)

For PDG models. Allows the gas log heater to be turned on and off by using a hand-held remote control. This remote comes installed in BTB models.

REMOTE CONTROL RECEIVER BRACKET - 112806-02

(Not Shown)

For PDG models only. Used for mounting remote control receiver to unit base. **WALL-MOUNT ON/OFF SWITCH GWMS2 (Not Shown)**

For all models. Allows the gas log heater to be turned on and off with a wall switch. This switch is included with all models.

DAMPER CLAMP - GA6080 (Not Shown)

For all models. Permanently opens chimney flue damper for vented operation. This is included with all models.

LAVA ROCK - GA6060 (Not Shown)

For all models. Order when additional rock is desired. (1.8 lb. bag)

CLEANING KIT - GCK (Not Shown)

For all models. Your vent-free gas appliance requires regular cleaning and maintenance to prevent performance problems. This kit gives you the tools and instructions to make it easy to clean all critical areas of your appliance.

INFORMATION VIDEO - 108917-01

For all models. A care and maintenance video is available by calling 1-866-672-6040.

ILLUSTRATED PARTS BREAKDOWN

MODELS VTD-18N-PDG, VTD-18P-PDG, VTD-18N-BTB AND VTD-18P-BTB

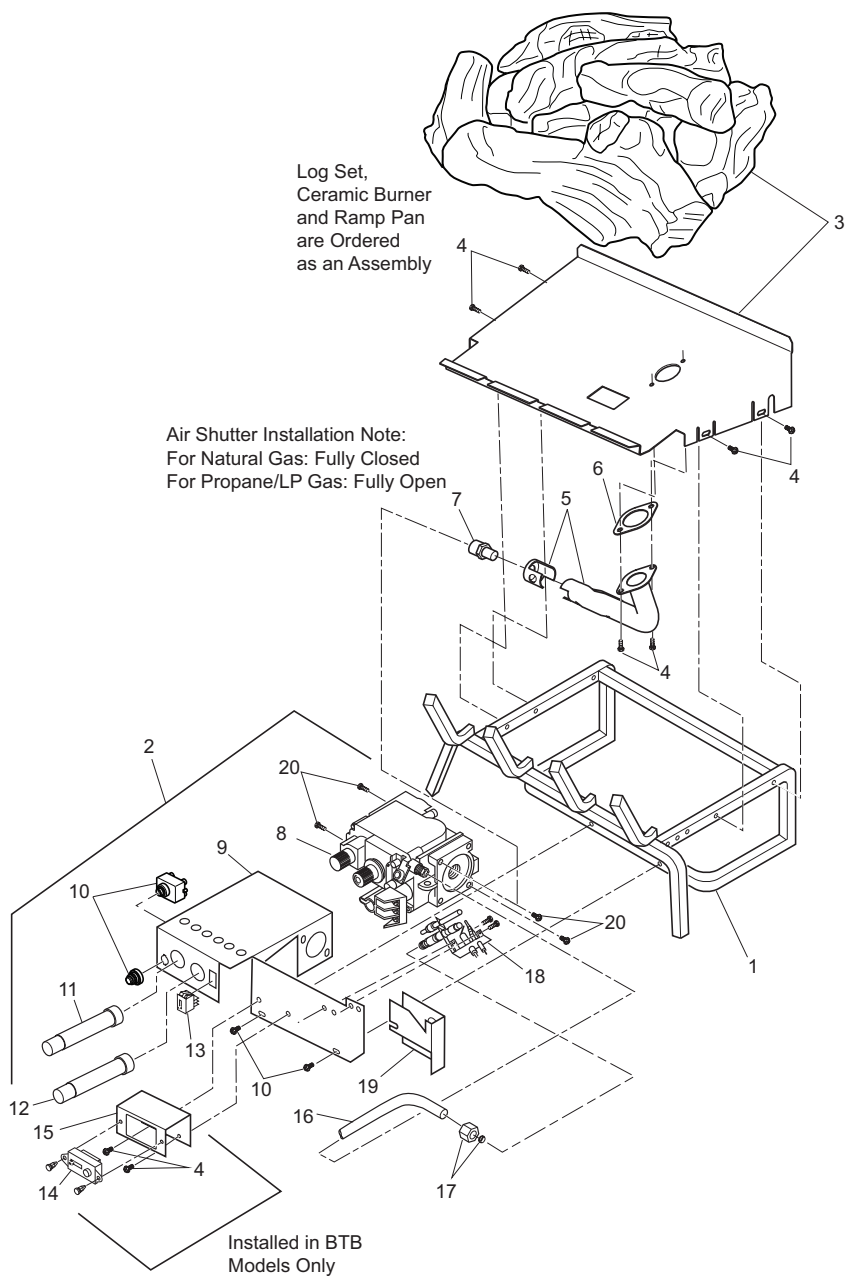

PARTS LIST

This list contains replaceable parts used in your fireplace. When ordering parts, follow the instructions listed under *Replacement Parts* on page 19 of this manual.

KEY NO.	PART NO.	DESCRIPTION					QTY.
			VTD-18N-PDG	VTD-18P-PDG	VTD-18N-BTB	VTD-18P-BTB	
1	111808-01	Grate Assembly	•	•	•	•	1
2	111794-03	Valve-Bracket Assembly	•	•	•	•	1
	111794-04	Valve-Bracket Assembly	•	•	•	•	1
3	112789-01	Log Assembly	•	•	•	•	1
	112790-01	Log Assembly	•	•	•	•	1
4	111800-01	Screw	•	•	•	•	14
	111800-01	Screw	•	•	•	•	10
5	112372-02	Venturi/Shutter Assembly	•	•	•	•	1
6	112370-01	Gasket	•	•	•	•	1
7	112371-03	Orifice	•	•	•	•	1
	112371-04	Orifice	•	•	•	•	1
8	111807-01	Valve NG	•	•	•	•	1
	111807-02	Valve LP	•	•	•	•	1
9	116791-01	Valve Bracket	•	•	•	•	1
10	111435-01	Electronic Ignitor	•	•	•	•	1
11	103784-01	Control Knob Extension	•	•	•	•	1
12	103784-02	Control Knob Extension	•	•	•	•	1
13	099998-01	Fan Switch	•	•	•	•	1
14	112806-01	Remote Control Assembly	•	•	•	•	1
15	112806-02	Remote Receiver Bracket	•	•	•	•	1
16	111817-02	Flextube 3/16"	•	•	•	•	1
17	111828-01	Compression Nut/Sleeve	•	•	•	•	1
18	112376-01	Pilot	•	•	•	•	1
	103778-01	Pilot	•	•	•	•	1
19	111796-02	Pilot Shield	•	•	•	•	1
20	111816-01	Screw	•	•	•	•	4
PARTS AVAILABLE NOT SHOWN							
	100563-01	Warning Plate	•	•	•	•	1
	103877-01	Lighting Instruction Plate	•	•	•	•	1
	100639-01	Caution Decal	•	•	•	•	1
	GA6060	Lava Rock	•	•	•	•	1
	111288-02	Gas Flex Line 18"	•	•	•	•	1
	112363-01	Log Scrap Kit #1	•	•	•	•	1
	112364-01	Log Scrap Kit #2	•	•	•	•	1

ILLUSTRATED PARTS BREAKDOWN

MODELS VTD-24N-PDG, VTD-24P-PDG, VTD-24N-BTB AND VTD-24P-BTB

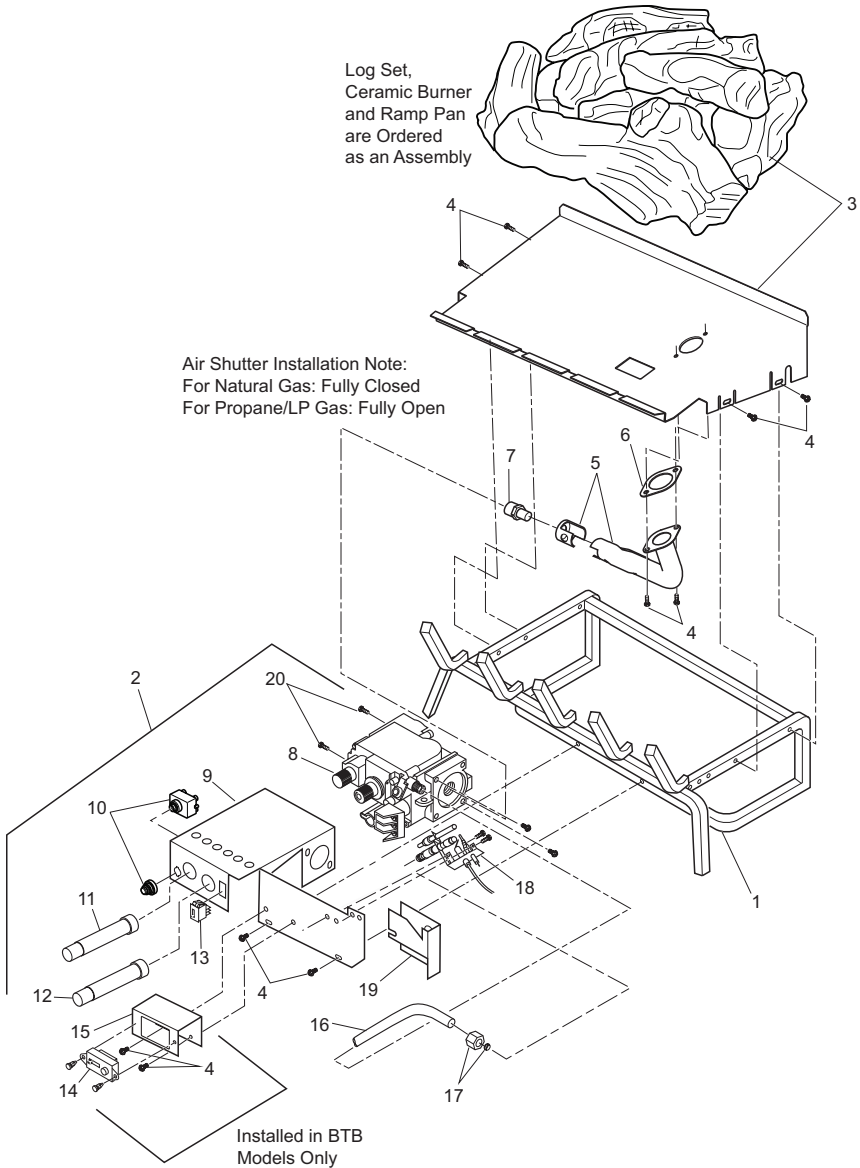

PARTS LIST

This list contains replaceable parts used in your fireplace. When ordering parts, follow the instructions listed under *Replacement Parts* on page 19 of this manual.

KEY NO.	PART NO.	DESCRIPTION					QTY.
			VTD-24N-PDG	VTD-24P-PDG	VTD-24N-BTB	VTD-24P-BTB	
1	111793-01	Grate Assembly	•	•	•	•	1
2	111794-01	Gas Train Assembly	•	•	•	•	1
	111794-05	Gas Train Assembly	•	•	•	•	1
3	112359-01	Log Assembly	•	•	•	•	1
	112360-01	Log Assembly	•	•	•	•	1
4	111800-01	Screw	•	•	•	•	14
	111800-01	Screw	•	•	•	•	10
5	112372-01	Venturi/Shutter Assembly	•	•	•	•	1
6	112370-01	Gasket	•	•	•	•	1
7	112371-01	Orifice	•	•	•	•	1
	112371-02	Orifice	•	•	•	•	1
8	111807-01	Valve	•	•	•	•	1
	111807-02	Valve	•	•	•	•	1
9	116791-01	Valve Bracket	•	•	•	•	1
10	111435-01	Electronic Ignitor	•	•	•	•	1
11	103784-01	Control Knob Extension	•	•	•	•	1
12	103784-02	Control Knob Extension	•	•	•	•	1
13	099998-01	Fan Switch	•	•	•	•	1
14	112806-01	Remote Control Assembly	•	•	•	•	1
15	112806-02	Remote Receiver Bracket	•	•	•	•	1
16	111817-02	Flextube 3/16"	•	•	•	•	1
17	111828-01	Compression Nut/Sleeve	•	•	•	•	1
18	112376-01	Pilot	•	•	•	•	1
	103778-01	Pilot	•	•	•	•	1
19	111796-02	Pilot Shield	•	•	•	•	1
20	111816-01	Screw	•	•	•	•	4
PARTS AVAILABLE NOT SHOWN							
	100563-01	Warning Plate	•	•	•	•	1
	103877-01	Lighting Instruction Plate	•	•	•	•	1
	100639-01	Caution Decal	•	•	•	•	1
	GA6060	Lava Rock	•	•	•	•	1
	111288-02	Gas Flex Line 18"	•	•	•	•	1
	112363-01	Log Scrap Kit #1	•	•	•	•	1
	112364-01	Log Scrap Kit #2	•	•	•	•	1

WARRANTY INFORMATION

KEEP THIS WARRANTY

Model _____
Serial No. _____
Date Purchased _____

Always specify model and serial numbers when communicating with the factory.

We reserve the right to amend these specifications at any time without notice. The only warranty applicable is our standard written warranty. We make no other warranty, expressed or implied.

LIMITED WARRANTY

VENTED GAS LOG HEATERS

DESA warrants this product to be free from defects in materials and components for four (4) years from the date of first purchase, provided that the product has been properly installed, operated and maintained in accordance with all applicable instructions. To make a claim under this warranty the Bill of Sale or cancelled check must be presented.

This warranty is extended only to the original retail purchaser. This warranty covers the cost of part(s) required to restore this heater to proper operating condition and an allowance for labor when provided by a DESA Authorized Service Center. Warranty part(s) MUST be obtained through authorized dealers of this product and/or DESA who will provide original factory replacement parts. Failure to use original factory replacement parts voids this warranty. The heater MUST be installed by a qualified installer in accordance with all local codes and instructions furnished with the unit.

This warranty does not apply to parts that are not in original condition because of normal wear and tear or parts that fail or become damaged as a result of misuse, accidents, lack of proper maintenance or defects caused by improper installation. Travel, diagnostic cost, labor, transportation and any and all such other costs related to repairing a defective heater will be the responsibility of the owner.

TO THE FULL EXTENT ALLOWED BY THE LAW OF THE JURISDICTION THAT GOVERNS THE SALE OF THE PRODUCT; THIS EXPRESS WARRANTY EXCLUDES ANY AND ALL OTHER EXPRESSED WARRANTIES AND LIMITS THE DURATION OF ANY AND ALL IMPLIED WARRANTIES, INCLUDING WARRANTIES OF MERCHANTABILITY AND FITNESS FOR A PARTICULAR PURPOSE TO FOUR (4) YEARS ON ALL COMPONENTS FROM THE DATE OF FIRST PURCHASE; AND DESA'S LIABILITY IS HEREBY LIMITED TO THE PURCHASE PRICE OF THE PRODUCT AND DESA SHALL NOT BE LIABLE FOR ANY OTHER DAMAGES WHATSOEVER INCLUDING INDIRECT, INCIDENTAL OR CONSEQUENTIAL DAMAGES.

Some states do not allow a limitation on how long an implied warranty lasts or an exclusion or limitation of incidental or consequential damages, so the above limitation on implied warranties or exclusion or limitation on damages may not apply to you.

This warranty gives you specific legal rights and you may also have other rights that vary from state to state.

For information about this warranty write:



2701 Industrial Drive
P.O. Box 90004
Bowling Green, KY 42102-9004
www.desatech.com



111826 02
NOT A UPC

111826-02
Rev. J
05/06